

FrymaKoruma
› technology in motion

FrymaKoruma Mills
The new standard in milling technology

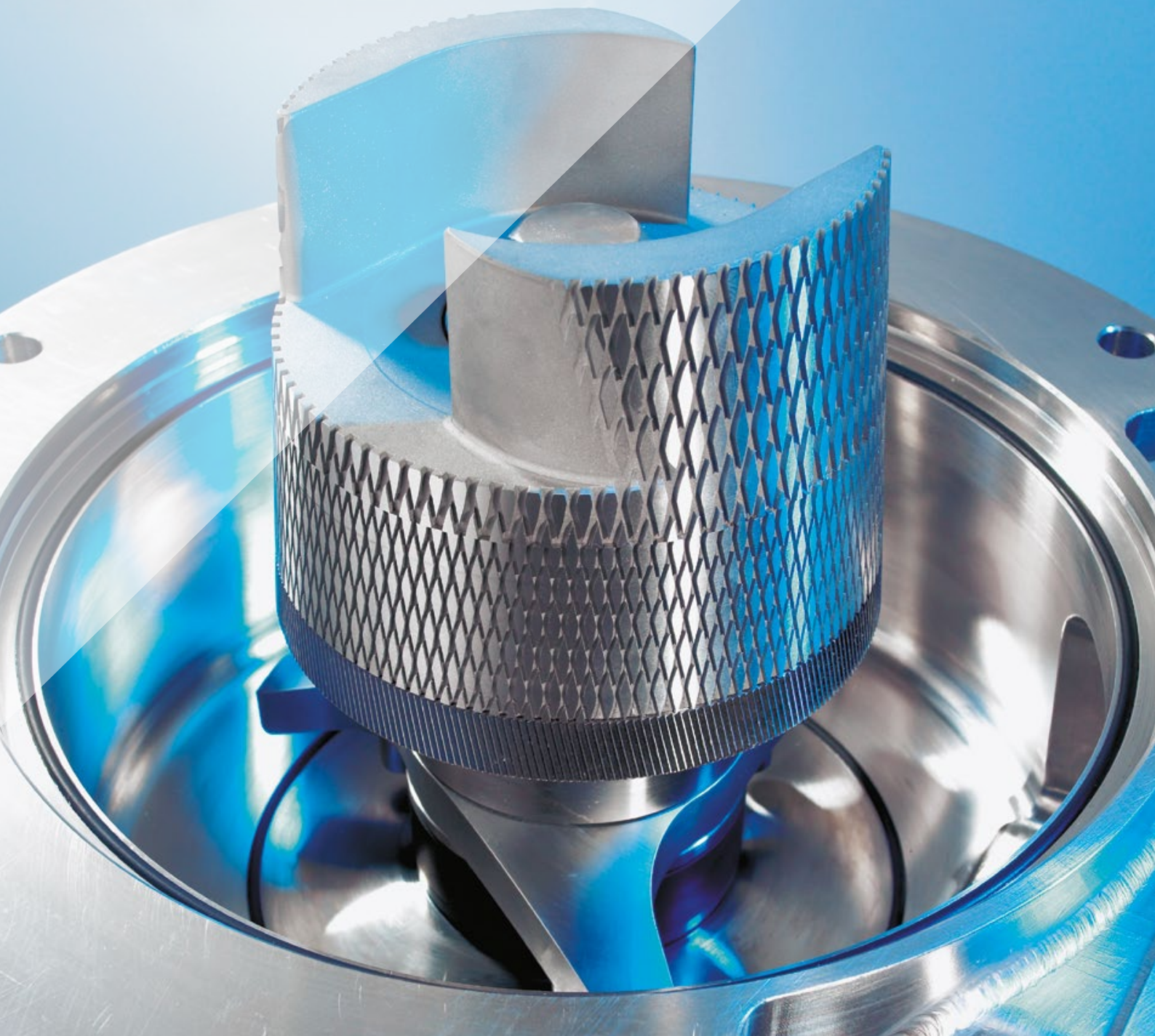



The new standard in milling technology

Highly efficient, outstandingly hygienic and extremely versatile – just three of many good reasons to choose FrymaKoruma mills. Used in laboratories and on production lines in many industries, FrymaKoruma mills are suited to a vast range of applications. The portfolio includes perforated disc, toothed colloid and corundum stone mills. Since the milling tools are interchangeable, all mills can be used for a wide range of purposes – precisely adaptable to the products to be processed.

Products are loaded via a hopper that can also be fitted with a feed screw, or via a pump. The milling zone is sealed by an innovative, single or double acting mechanical seal, with no dead space. All product contact surfaces are very easily cleaned with no need for dismantling (CIP). Thanks to optimised residue discharge and thorough washing of all static seals during the cleaning process, compliance with the highest hygiene standards (GMP, DIN EN 1672) is assured. In all industrial sectors, demands in terms of flexibility and hygiene management are constantly on the increase. The latest range of FrymaKoruma mills sets new standards in both areas – with no compromise in throughput.

Options

- /// Automatic milling gap adjustment for MK
- /// Product contacting surfaces. Ra ≤ 0.4 µm (pharma finish)
- /// Tri-Clamp, flange connections
- /// Heated/cooled inlets and outlets
- /// Explosion-proof design (ATEX, EEx e, EEx de)
- /// Double acting mechanical seal
- /// Feed pumps, hopper, feed screws
- /// Conversion kits for all types
- /// Further options upon request

Key benefits

- /// Innovative grinding technology
- /// Optimum product chamber design minimizes product loss
- /// Optimized sealing technology
- /// Design conforms to GMP
- /// CIP-compatible
- /// High energy density with high throughput in the smallest space





Perforated disc mill (ML)

Perforated disc mills are used for initial size reduction and pre-milling of bulky products, pulping and mashing of bulky solids (e.g. fruit and vegetables). The knife arm rotates at around 3000 rpm, very close to the perforated disc, processing the product as it is fed in axially. The cutting and impact forces produced reduce size and force the product through the apertures in the disc. Perforated discs are available with a range of aperture sizes. The rotating ejector bar beneath the disc transfers the finished product to the mill outfeed.

- /// Fruits and vegetables
- /// Fruit juices, vegetable juices
- /// Recycling, e.g. paper or leather waste
- /// Meat, fish
- /// Pet food



Toothed colloid mill (MZ)

The principal application for toothed colloid mills is wet milling of fluids and high-viscosity suspensions and emulsions. FrymaKoruma mills can be supplied with a range of colloid milling sets, enabling optimal tailoring to each product. The standard milling set is suitable for universal use. The coarse toothed set is ideal for size reduction of solids in suspensions, while the cross-toothed set is used where smaller particle sizes and finer dispersion are required. Adjustment of the milling gap between rotor and stator allows optimal setting for every product, while stepless milling gap adjustment is available as an option for both manual and automatic adjustment. The gap width is indicated on a gauge.

- /// Juices
- /// Soy milk
- /// Hazelnuts
- /// Grease
- /// Pesticides
- /// Paper coatings
- /// Paints and varnishes



Corundum stone mill (MK)

Corundum stone mills are used for dispersion and wet milling of liquid, viscous and pasty products. At the heart of these mills are the corundum stones, which are available with various grains to suit demand. The rotor element rotates against the fixed stator at high speed, achieving size reduction of the product in the milling gap through extreme shear and cutting forces. Axial milling gap control also allows adjustment of the pressure between rotor and stator, even during operation (negative gap adjustment). These units can also be fitted with automatic milling gap adjustment as an optional extra.

- /// Mustard
- /// Sesame
- /// Pet food
- /// Humus
- /// Nut pastes, chocolate
- /// Make-up, creams
- /// Lubrication grease

Particle size

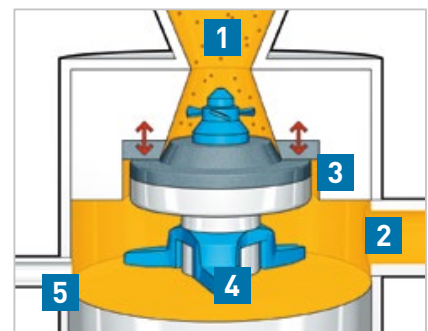
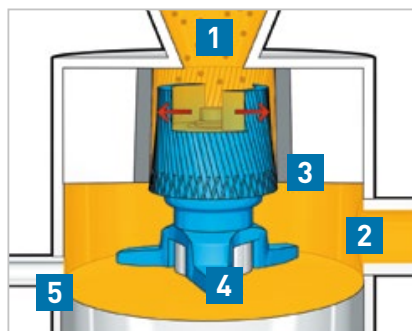
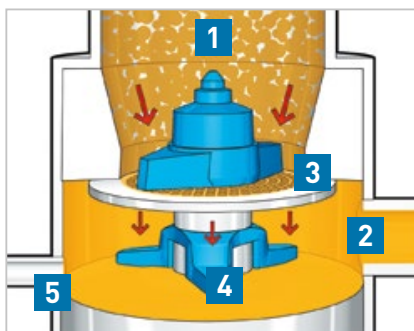

- 1 Product infeed 2 Product discharge 3 Grinding gap 4 Ejector 5 Residue discharge

Perforated disc mill (ML)

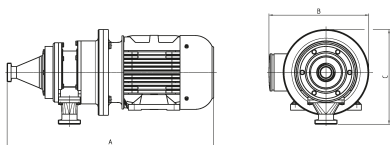

Toothed colloid mill (MZ)

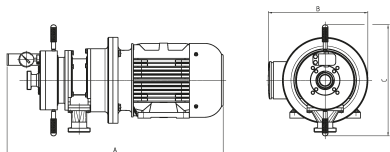

Corundum stone mill (MK)

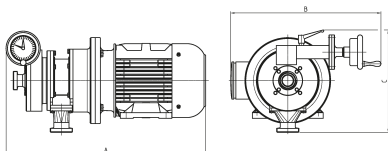

	Throughput (l/h), approx.	Installed power (kW)	Dimensions (mm)			Weight (kg), approx.
			Length	Width	Height	
ML 150	200–2500	5.5	750	360	330	85
ML 180	1000–12000	15	950	430	450	250
ML 250	4000–20000	30	1050	450	450	390
ML 330	8000–40000	60	1310	670	630	500
MZ 80	100–1000	5.5	680	360	330	100
MZ 100	200–2000	5.5	680	360	330	100
MZ 110	300–3000	5.5	680	360	330	100
MZ 130	700–7000	15	900	430	450	300
MZ 150	1500–15000	22	950	430	450	310
MZ 190	2600–26000	45	1130	610	510	700
MZ 250	4000–40000	60	1330	740	650	1100
MK 95	10–160	5.5	680	540	360	100
MK 160	30–500	11	1030	540	620	200
MK 180	50–1000	15	1030	540	620	200
MK 250	90–2000	22	830	670	1000	400
MK 300	150–3000	37	830	600	1220	650
MK 320	200–5000	37	830	600	1220	650

For over 65 years, FrymaKoruma has been a leading international supplier of processing machinery and equipment for the pharmaceutical, cosmetics, food and chemical industries. Based in Germany and Switzerland, the company employs about 150 people. Our goal is not simply to meet all our customers' expectations without any ifs and buts; we also attach great importance to the development of long-term partnerships. Our pursuit of this objective is altogether successful – over 23000 installations are currently in use in more than 180 different countries.

Customer support

FrymaKoruma is more than just a supplier of machines and plant. As a customer focused partner for plant engineering, we take an idea and turn it into a high-tech solution that matches your requirements exactly – with installation, documentation and commissioning from one source. If you need to be further

convinced before you commit yourself, ProTec – our process technology and training centre – lets you do just that. Profit from our specialists' vast know-how and years of experience in the development of liquid and semi-solid products. In our well-equipped, modern laboratory, you can develop or optimize recipes, test machine models, scale up processes and produce test batches for pharmaceutical, cosmetics, food or chemical applications.

Our Customer Service, which is available worldwide, makes sure you continue to keep abreast of a constantly evolving market long after the development and manufacture of your plant has finished. It includes much more than simply maintenance, modifications and upgrading. We also advise and support you in all matters relating to your equipment, provide on-site training and stock a range of spare parts which can be shipped to you promptly.

FrymaKoruma AG
Theodorshofweg
4310 Rheinfelden / Switzerland
phone +41 61 8364-141
fax +41 61 8312-000

FrymaKoruma GmbH
Sales / ProTec
Fischerstraße 10
79395 Neuenburg / Germany
phone +49 7631 7067-0
fax +49 7631 7067-29

info@frymakoruma.com
www.frymakoruma.com

member of >
ProXES
the processing > group