



FrymaKoruma Corundum Stone Mill MK 250

For wet grinding and dispersing

Wet grinding with unbeatable advantages

The FrymaKoruma corundum stone mills are used for dispersing and wet grinding of liquid and pasty products. The heart of these mills are the corundum stones. At high speed the rotor element rotates against the stationary stator element. In the gap between the two corundum stones, the product is subjected to high shearing, cutting and crushing forces.

Amongst others, the main applications of the corundum stone mill are mustard, food and baby food, soy milk, sesame, lipstick compound, lubrication grease, coatings and varnishes.

Key Benefits:

- ◆ high energy density
- ◆ high throughput
- ◆ optimized seal technology
- ◆ adjustable grinding gap
- ◆ exchangeable tools

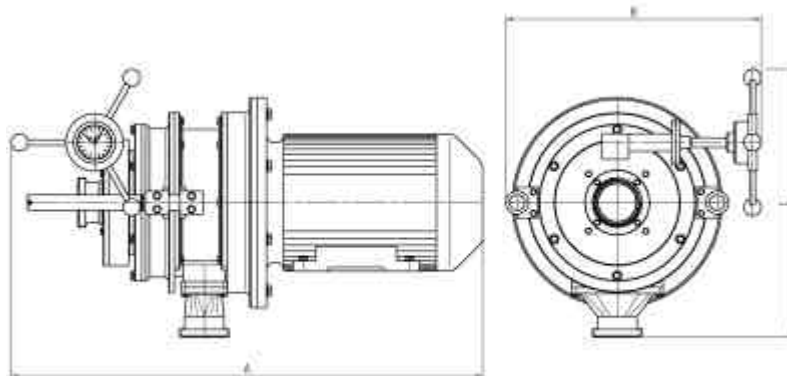

A Unit of Robbins & Myers, Inc.

Throughput (standard)	90 – 2000 kg/h		
Hopper (Option)	75 l		
Product inlet	DN 100		
Product outlet	DN 100		
Pressure resistance	max. 6 bar		
Driving capacity (standard)	22 kW	3000 rpm / 50 Hz	
Dimensions (approx.) [mm]	A = 1240	B = 670	C = 710
Weight (approx.) [kg]	280		

technical data subject to modification

© 2004 Romaco AG

FRY_4EN_MK 0250_1104